

hotcontrol Temperature Controller C 148

User's Manual



WARNING SYMBOL

 The Symbol calls attention to an operating procedure, practice, or the like, which, if not correctly performed or adhered to, could result in personal injury or damage to or destruction of part or all of the product and system. Do not proceed beyond a warning symbol until the indicated conditions are fully understood and met.

Use the Manual

Installers	Read Chapter 1, 2
System Designer	Read All Chapters
Expert User	Read Page 10

Note: It is strongly recommended that a process should incorporate a LIMIT CONTROL which will shut down the equipment at a preset process condition in order to preclude possible damage to products or system.

Information in this user's manual is subject to change without notice.

This manual is applicable for the products with software version 23 and later version.

Die deutsche Bedienungsanleitung finden Sie auf unserer homepage

You will find the German user manual on our homepage

<https://www.hotset.com/de/downloads/downloads/>

Chapter 1 Overview

1-1 General	5
1-2 Keys and Displays	8
1-3 Menu Overview	10
1-4 Parameter Descriptions	11

Chapter 2 Installation

2-1 Unpacking	18
2-2 Mounting	18
2-3 Wiring precautions	19
2-4 Power Wiring	21
2-5 Sensor Installation Guidelines	21
2-6 Sensor Input Wiring	22
2-7 Control Output Wiring	22
2-8 Alarm Wiring	23

Chapter 3 Programming

3-1 Lockout	24
3-2 Signal Input	24
3-3 Control Outputs	25
3-4 Alarm	29
3-5 Configure User Menu	30
3-6 Ramp	31
3-7 Dwell Timer	32
3-8 PV Shift	33
3-9 Digital Filter	34
3-10 Failure Transfer	35
3-11 Auto-tuning	36
3-12 Manual tuning	38
3-13 Manual Control	39

Chapter 4 Specifications

Specifications	40
----------------	----

Appendix

A-1 Error Codes	45
-----------------	----

Contents

FIGURES & TABLES PAGE NO

Figure 1.1	Fuzzy Control Advantage	6
Figure 1.3	Front Panel Description	9
Figure 1.4	Display of Initial Stage	9
Figure 2.1	Mounting Dimensions	19
Figure 2.3	Lead Termination	20
Figure 2.6	Rear Terminal Connection	20
Figure 2.7	Power Supply Connections	21
Figure 2.8	Sensor Input Wiring	22
Figure 2.11	Output 1 Pulsed Voltage to Drive SSR	22
Figure 2.19	Alarm Output to Drive Load	23
Figure 2.20	Alarm Output to Drive Contactor	23
Figure 3.2	Heat Only ON-OFF Control	25
Figure 3.3	Deviation High Alarm	28
Figure 3.4	Process Low Alarm	28
Figure 3.5	RAMP Function	31
Figure 3.6	Dwell Timer Function	32
Figure 3.7	PV Shift Application	33
Figure 3.8	Filter Characteristics	34
Figure 3.9	Effects of PID Adjustment	39
Table 1.1	Display Form of Characters	9
Table 3.2	PID Adjustment Guide	38
Table A.1	Error Codes and Corrective Actions	45

The Fuzzy Logic plus PID microprocessor-based controller series, incorporate two bright, easy to read 4-digit LED displays, indicating process value and set point value. The Fuzzy Logic technology enables a process to reach a predetermined set point in the shortest time, with the minimum of overshoot during power-up or external load disturbance.

C148 is a 1/16 DIN size panel mount controller. The unit is powered by 90-250 VAC or 11-26 VDC / VAC supply, incorporating a 14V / 40mA output for SSR as standard. There are six types of alarm plus a dwell timer can be configured for the alarm output.

The units are fully programmable for PT100 and thermocouple types „J, K, T, E, B, R, S, N, L“ with no need to modify the unit. The input signal is digitized by using a 18-bit A to D converter. Its fast sampling rate allows the unit to control fast processes.

By using proprietary Fuzzy modified PID technology, the control loop will minimize the overshoot and undershoot in a shortest time. The following diagram is a comparison of results with and without Fuzzy technology.

Figure 1.1 Fuzzy Control Advantage

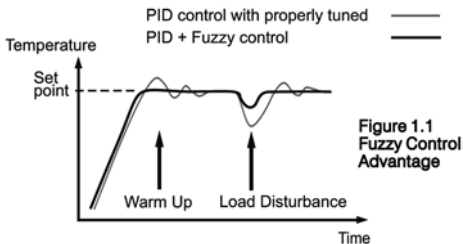

High Accuracy

The series are manufactured with custom designed ASIC(Application Specific Integrated Circuit) technology which contains a 18-bit A to D converter for high resolution measurement (true 0.1°F resolution for thermocouple and PT100) The ASIC technology provides improved operating performance, low cost, enhanced reliability and higher density.

Fast Sampling Rate

The sampling rate of the input A to D converter reaches 5 times / second. The fast sampling rate allows this series to control fast processes.

Fuzzy Control

The function of Fuzzy control is to adjust PID parameters from time to time in order to make manipulation output value more flexible and adaptive to various processes. The results is to enable a process to reach a pre-determined set point in the shortest time, with the minimum of overshoot and undershoot during power-up or external load disturbance.

Auto-tune

The auto-tune function allows the user to simplify initial setup for a new system. A clever algorithm is provided to obtain an optimal set of control parameters for the process, and it can be applied either as the process is warming up (cold start) or as the process has been in steady state (warm start).

Lockout Protection

According to actual security requirement, one of four lockout levels can be selected to prevent the unit from being changed abnormally.

Bumpless Transfer

Bumpless transfer allows the controller to continue to control by using its previous value as the sensor breaks. Hence, the process can be well controlled temporarily as if the sensor is normal.

Soft-start Ramp

The ramping function is performed during power up as well as any time the set point is changed. It can be ramping up or ramping down. The process value will reach the set point with a predetermined constant rate.

Digital Filter

A first order low pass filter with a programmable time constant is used to improve the stability of process value. This is particularly useful in certain application where the process value is too unstable to be read.

SEL Function

The units have the flexibility for user to select those parameters which are most significant to him and put these parameters in the front of display sequence. There are at most 8 parameters can be selected to allow the user to build his own display sequence.

KEYPAD OPERATION

SCROLL KEY

This key is used to select a parameter to be viewed or adjusted.

DOWN KEY

This key is used to decrease the value of selected parameter.

RESET KEY

This key is used to:

1. Revert the display to display the process value.
2. Reset the latching alarm, once the alarm condition is removed.
3. Stop the manual control mode, auto-tuning mode and calibration mode.
4. Clear the message of communication error and auto-tuning error.
5. Restart the dwell timer when the dwell timer has been time out.
6. Enter the manual control menu during failure mode occurs.

UP KEY

This key is used to increase the value of selected parameter.

ENTER KEY

Press  for 5 seconds or longer.

Press  for 5 seconds to:

1. Enter setup menu. The display shows **SEt**.
2. Enter manual control mode during manual control mode is **MANd** selected.
3. Enter auto-tuning mode during auto-tuning mode **RT** is selected.
4. Perform calibration to a selected parameter during the calibration procedure.

Press  for 6.2 seconds to select manual control mode.

Press  for 7.4 seconds to select auto-tuning mode.

Press  for 8.6 seconds to select calibration mode.

Figure 1.3 Front Panel Description

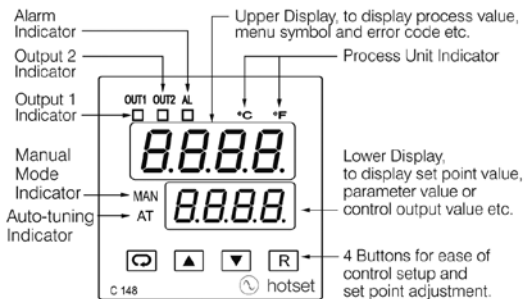
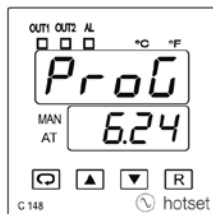

Table 1.1 Display Form of Characters

A	À	E	É	I	Ì	N	Ñ	S	Š	X	
B	Ɓ	F	Ƒ	J	Ƶ	O	Ɔ	T	Ƨ	Y	Ƴ
C	Ƈ	G	Ɠ	K	Ƙ	P	Ɔ	U	Ʊ	Z	
c	Ƈ	H	Ƨ	L	Ƶ	Q		V	Ʊ	?	Ɔ
D	d	h	h	M	ñ	R	r	W	=	=	

▣: Confused Character

Figure 1.4 Display of Initial Stage



Display program code of the product for 2.5 seconds.

The left diagram shows program no. 6 for C148 with version 24.

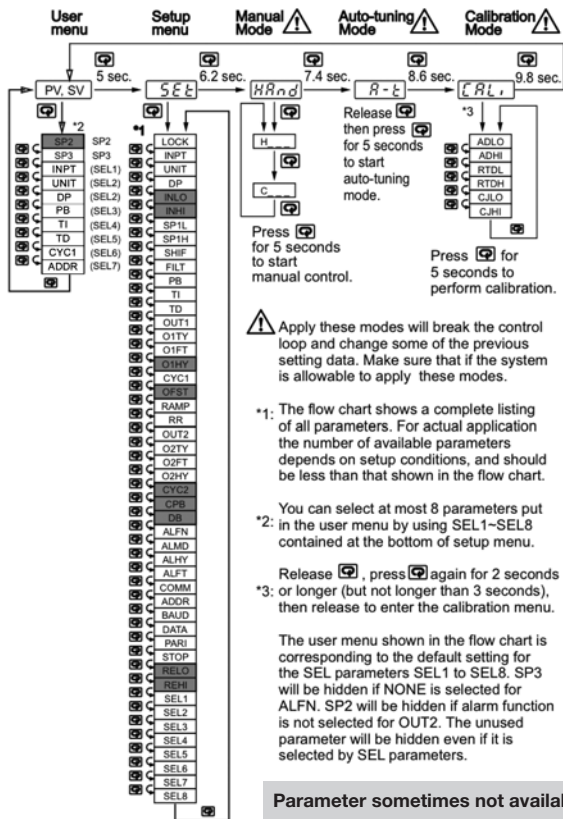

Parameter sometimes not available or are not changeable!

Parameter Notation	Parameter Description	Range	Default Value
SP1	Set point for output 1	Low: SP1L High :SP1H	25.0 °C (77.0°F)
SP2	Set point for output 2 when output 2 performs alarm function	Low: -19999 High :45536	10.0 °C (18.0°F)
SP3	Set point for alarm or dwell timer output	Low: -19999 High: 45536	10.0 °C (18.0°F)
LOCK	Select parameters to be locked	0 none No parameter is locked 1 SEt Setup data are locked 2 uSEr Setup data and User data except Set point are locked 3 ALL All data are locked	0
INPT	Input sensor selection	0 J-tC J type thermocouple 1 K-tC K type thermocouple 2 T-tC T type thermocouple 3 E-tC E type thermocouple 4 B-tC B type thermocouple 5 R-tC R type thermocouple 6 S-tC S type thermocouple 7 N-tC N type thermocouple 8 L-tC L type thermocouple 9 Pt.100 PT 100 ohms DIN curve 10 Pt. JIS PT 100 ohms JIS curve 11 4-20 4-20 mA linear current input 12 0-20 0-20 mA linear current input 13 0-60 0-60 mV linear millivolt input 14 0-1V 0-1V linear voltage input 15 0-5V 0-5V linear voltage input 16 1-5V 1-5V linear voltage input 17 0-10 0-10V linear	0

Parameter Notation	Parameter Description	Range	Default Value
UNIT	Input unit selection	0 °C : Degree C unit	0
		1 °F : Degree F unit	
		2 P.V. : Process unit	
DP	Decimal point selection	0 no.dP : No decimal point	0
		1 1-dP : 1 decimal digit	
		2 2-dP : 2 decimal digits	
		3 3-dP : 3 decimal digits	
INLO	Input low scale value	Low: -19999 High: 45486	-17.8 °C (0 °F)
INHI	Input high scale value	Low: INLO+50 High: 45536	93.3 °C (200.0 °F)
SP1L	Low limit of set point value	Low: -19999 High: 45536	-17.8 °C (0 °F)
SP1H	High limit of set point value	Low: SP1L High: 45536	537.8 °C (1000 °F)
SHIF	PV shift (offset) value	Low: -200.0 °C (-360.0 °F) High: 200.0 °C (360.0 °F)	0.0
FILT	Filter damping time constant of PV	0 0 0 second time constant	2
		1 0.2 0.2 second time constant	
		2 0.5 0.5 second time constant	
		3 1 1 second time constant	
		4 2 2 seconds time constant	
		5 5 5 seconds time constant	
		6 10 10 seconds time constant	
		7 20 20 seconds time constant	
		8 30 30 seconds time constant	
		9 60 60 seconds time constant	

Parameter Notation	Parameter Description	Range	Default Value
PB	Proportional band value	Low: 0 High: 500.0 °C (900.0 °F)	10.0 °C (18.0 °F)
TI	Integral time value	Low: 0 High: 1000 sec	100
TD	Derivative time value	Low: 0 High: 360.0 sec	25.0
OUT1	Output 1 function	0 Reverse (heating) control action 1 Direct (cooling) control action	0
O1TY	Output 1 signal type	0 Relay output 1 Solid state relay drive output 2 Solid state relay output 3 4-20 4-20 mA current module 4 0-20 0-20 mA current module 5 0-1V 0-1V voltage module 6 0-5V 0-5V voltage module 7 1-5V 1-5V voltage module 8 0-10V 0-10V voltage module	1
O1FT	Output 1 failure transfer mode	Select BPLS (bumpless transfer) or 0.0 ~ 100.0 % to continue output 1 control function as the unit fails, or select OFF (0) or ON (1) for ON-OFF control.	0
O1HY	Output 1 ON-OFF control hysteresis	Low: 0.1 High: 50.0 °C(90.0°F)	0.1°C (0.2°F)
CYC1	Output 1 cycle time	Low: 0.1 High: 90.0 sec.	1
OFST	Offset value for P control	Low: 0 High: 100.0 %	25.0
RAMP	Ramp function selection	0 No Ramp Function 1 Use unit/minute as Ramp Rate 2 Use unit/hour as Ramp Rate	0

Parameter Notation	Parameter Description	Range	Default Value
RR	Ramp rate	Low: 0 High: 500.0 °C (900.0 °F)	0.0
OUT2	Output 2 function	0 NONE Output 2 No Function 2 dE.H. Deviation High Alarm 3 dE.L. Deviation Low Alarm 6 P.H. Process High Alarm 7 P.L. Process Low Alarm 8 Cool Cooling PID Function	2
O2TY	Output 2 signal type	0 RELY Relay output 1 SSRd Solid state relay drive output 2 SSR Solid state relay output 3 4-20 4-20 mA current module 4 0-20 0-20 mA current module 5 0-1V 0-1V voltage module 6 0-5V 0-5V voltage module 7 0-5V 1-5V voltage module 8 0-10 0-10V voltage module	0
O2FT	Output 2 failure transfer mode	Select BPLS (bumpless transfer) or 0.0 ~ 100.0 % to continue output 2 control function as the unit fails, or select ON (0) or OFF (1) for alarm function.	0
O2HY	Output 2 hysteresis value when output 2 performs alarm function	Low: 0.1 High: 50.0 °C (90.0 °F)	0.1 °C (0.2 °F)
CYC2	Output 2 cycle time	Low: 0.1 High: 90.0 sec.	18.0
CPB	Cooling proportional band value	Low: 50 High: 300%	100

Parameter Notation	Parameter Description	Range	Default Value
DB	Heating-cooling dead band (negative value=overlap)	Low: -36.0 High: 36.0 %	0
ALFN	Alarm function for alarm output	0 none No alarm function 1 dwell Dwell timer action 2 dE.Hi Deviation high alarm 3 dE.Lo Deviation low alarm 4 db.Hi Deviation band out of band alarm 5 db.Lo Deviation band in band alarm 6 PV.Hi Process value high alarm 7 PV.Lo Process value low alarm	2
ALMD	Alarm operation mode	0 none Normal alarm action 1 latch Latching alarm action 2 hold Hold alarm action 3 latch Hold Latching & Hold action	0
ALHY	Hysteresis control of alarm	Low: 0.1 High:50.0 °C (90.0 °F)	0.1 °C (0.2 °F)
ALFT	Alarm failure transfer mode	0 on Alarm output ON as unit fails 1 off Alarm output OFF as unit fails	0
COMM	Communication function	0 none No communication 1 rtu Modbus RTU mode protocol 2 4-20 4-20mA retransmission output 3 0-20 0-20mA retransmission output 4 0-5V 0-5V retransmission output 5 1-5V 1-5V retransmission output 6 0-10 0-10V retransmission output	1

Parameter Notation	Parameter Description	Range	Default Value
ADDR	Address assignment of digital communication	Low: 1 High: 255	—
BAUD	Baud rate of digital communication	0 2.4 2.4 Kbits/s baud rate 1 4.8 4.8 Kbits/s baud rate 2 9.6 9.6 Kbits/s baud rate 3 14.4 14.4 Kbits/s baud rate 4 19.2 19.2 Kbits/s baud rate 5 28.8 28.8 Kbits/s baud rate 6 38.4 38.4 Kbits/s baud rate	2
DATA	Data bit count of digital communication	0 7 bits 7 data bits 1 8 bits 8 data bits	1
PARI	Parity bit of digital communication	0 EVEN Even parity 1 ODD Odd parity 2 NONE No parity bit	0
STOP	Stop bit count of digital communication	0 1 bit One stop bit 1 2 bits Two stop bits	0
RELO	Retransmission low scale value	Low: -19999 High: 45536	0.0 °C (32.0 °F)
REHI	Retransmission high scale value	Low: -19999 High: 45536	100.0 °C (212.0 °F)
SEL1	Select 1'st parameter for user menu	0 NONE No parameter selected 1 LOCK LOCK is put ahead 2 INPT INPT is put ahead 3 UNIT UNIT is put ahead 4 DP DP is put ahead 5 SHIF SHIF is put ahead 6 PB PB is put ahead 7 TI TI is put ahead	2



Parameter Notation	Parameter Description	Range	Default Value
SEL1	Select 1'st parameter for user menu	8 TD TD is put ahead 9 O1HY O1HY is put ahead 10 CYC1 CYC1 is put ahead 11 OFST OFST is put ahead 12 RR RR is put ahead 13 O2HY O2HY is put ahead 14 CYC2 CYC2 is put ahead 15 CPB CPB is put ahead 16 DB DB is put ahead 17 ADDR ADDR is put ahead 18 ALHY ALHY is put ahead	2
SEL2	Select 2'nd parameter for user menu	Same as SEL1	3
SEL3	Select 3'rd parameter for user menu	Same as SEL1	4
SEL4	Select 4'th parameter for user menu	Same as SEL1	6
SEL5	Select 5'th parameter for user menu	Same as SEL1	7
SEL6	Select 6'th parameter for user menu	Same as SEL1	8
SEL7	Select 7'th parameter for user menu	Same as SEL1	10
SEL8	Select 8'th parameter for user menu	Same as SEL1	17

2-1 Unpacking

2-2 Mounting

CHAPTER 2 INSTALLATION

 Dangerous voltages capable of causing death are sometimes present in this instrument. Before installation or beginning any cleaning or troubleshooting procedures the power to all equipment must be switched off and isolated. Units suspected of being faulty must be disconnected and removed to a properly equipped workshop for testing and repair. Component replacement and internal adjustments must be made by a qualified maintenance person only.

 This instrument is protected throughout by Double Insulation . To minimize the possibility of fire or shock hazards, do not expose this instrument to rain or excessive moisture.

 Do not use this instrument in areas under hazardous conditions such as excessive shock, vibration, dirt, moisture, corrosive gases or oil. The ambient temperature of the areas should not exceed the maximum rating specified in Chapter 4.

 Remove stains from this instrument using a soft, dry cloth. Don't use harsh chemicals, volatile solvent such as thinner or strong detergents to clean the instrument in order to avoid deformation or discoloration.

2-1 UNPACKING

Upon receipt of the shipment remove the unit from the carton and inspect the unit for shipping damage. If any damage due to transit, report and claim with the carrier. Write down the model number, serial number, and date code for future reference when corresponding with our service center. The serial number (S/N) and date code (D/C) are labeled on the box and the housing of control.

2-2 MOUNTING

Make panel cutout to dimension shown in Figure 2.1. Take both mounting clamps away and insert the controller into panel cutout. Install the mounting clamps back. Gently tighten the screws in the clamp till the controller front panels is fitted snugly in the cutout.

Figure 2.1 Mounting Dimensions

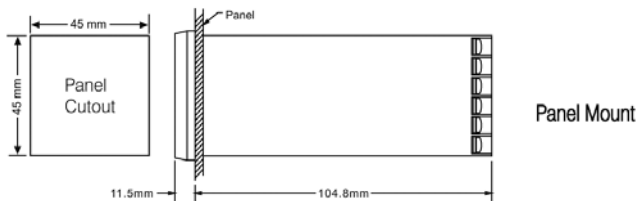

2-3 WIRING PRECAUTIONS

- Before wiring, verify the wiring label. Switch off the power while checking.
- Care must be taken to ensure that maximum voltage rating specified on the label are not exceeded.
- It is recommended that power of these units to be protected by fuses or circuit breakers rated at the minimum value possible.
- All units should be installed inside a suitably grounded metal enclosure to prevent live parts being accessible from human hands and metal tools.
- All wiring must conform to appropriate standards of good practice and local codes and regulations. Wiring must be suitable for voltage, current, and temperature rating of the system.
- Beware not to over-tighten the terminal screws. The torque should not exceed 1 N-m (8.9 Lb-in or 10.2KgF-cm).
- Unused control terminals should not be used as jumper points as they may be internally connected, causing damage to the unit.
- Verify that the ratings of the output devices and the inputs as specified in Chapter 4 are not exceeded.
- Except the thermocouple wiring, all wiring should use stranded copper conductor with maximum gauge 18 AWG (0,75mm²).

Figure 2.3 Lead Termination

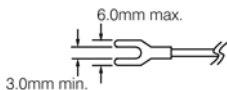
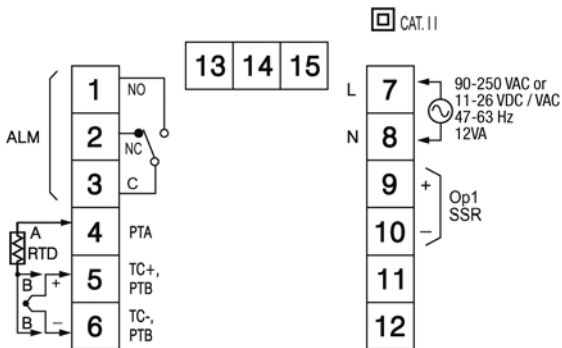

Figure 2.6 Rear Terminal Connection



50°C max. air ambient

Use copper conductors (except on T/C input)

The controller is supplied to operate at 90-250 VAC or 11-26 VDC / VAC. Check that the installation voltage corresponds with the power rating indicated on the product label before connecting power to the controller. Near the controller a fuse and a switch rated at 2A / 250VAC should be equipped as shown in the following diagram.

Figure 2.7 Power Supply Connections

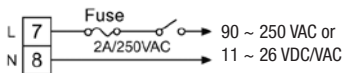

⚠ This equipment is designed for installation in an enclosure which provides adequate protection against electric shock. The enclosure must be connected to earth ground.

Local requirements regarding electrical installation should be rigidly observed. Consideration should be given to prevent from unauthorized person access to the power terminals.

2-5 Sensor Installation Guidelines

Proper sensor installation can eliminate many problems in a control system. The probe should be placed so that it can detect any temperature change with minimal thermal lag. In a process that requires fairly constant heat output, the probe should be placed closed to the heater. In a process where the heat demand is variable, the probe should be closed to the work area. Some experiments with probe location are often required to find this optimum position.

In a liquid process, addition of a stirrer will help to eliminate thermal lag. Since the thermocouple is basically a point measuring device, placing more than one thermocouple in parallel can provide an average temperature readout and produce better results in most air heated processes.

Proper sensor type is also a very important factor to obtain precise measurements. The sensor must have the correct temperature range to meet the process requirements. In special pro-

2-6 Sensor Input Wiring

2-7 Control Output Wiring

cesses the sensor might need to have different requirements such as leak-proof, anti-vibration, antiseptic, etc.

Standard sensor limits of error are ± 4 degrees F (± 2 degrees C) or 0.75% of sensed temperature (half that for special) plus drift caused by improper protection or an over-temperature occurrence. This error is far greater than controller error and cannot be corrected on the sensor except by proper selection and replacement.

2.6 Sensor Input Wiring

Figure 2.8 Sensor Input Wiring

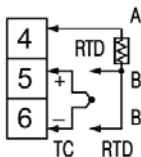

2.7 Control Output Wiring

Figure 2.11 Output 1 Pulsed Voltage to Drive SSR

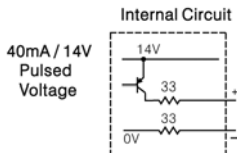
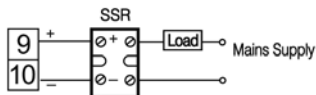

Figure 2.19 Alarm Output to Drive Load

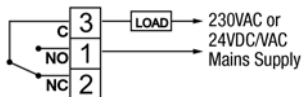
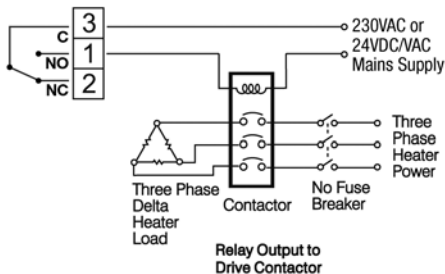



Figure 2.20 Alarm Output to Drive Contactor



3-1 Lockout

3-2 Signal Input

3. Programming

Press  for 5 seconds and release to enter setup menu. Press to select the desired parameter. The upper display indicates the parameter symbol, and the lower display indicates the selected value of parameter.

3-1 LOCKOUT

There are four security levels can be selected by using LOCK parameter.

If NONE is selected for LOCK, then no parameter is locked.

If SET is selected for LOCK, then all setup data are locked.

If USER is selected for LOCK, then all setup data as well as user data (refer to section 1-3) except set point are locked to prevent from being changed.

If ALL is selected for LOCK, then all parameters are locked to prevent from being changed.

3-2 SIGNAL INPUT

INPT: Selects the sensor type or signal type for signal input.

Range: (thermocouple)

J_TC, K_TC, T_TC, E_TC, B_TC, R_TC
S_TC, N_TC, L_TC
(RTD) PT.DN, PT.JS

UNIT: Selects the process unit

Range: °C, °F,

DP: Selects the resolution of process value.

Range: (for T/C and RTD) NO.DP, 1-DP

Heat Only ON-OFF Control: Select REVR for OUT1, Set PB to 0, O1HY is used to adjust dead band for ON-OFF control, The output 1 hysteresis (O1HY) is enabled in case of PB=0.

The heat only on-off control function is shown in the following diagram:

Figure 3.2 Heat Only ON-OFF Control

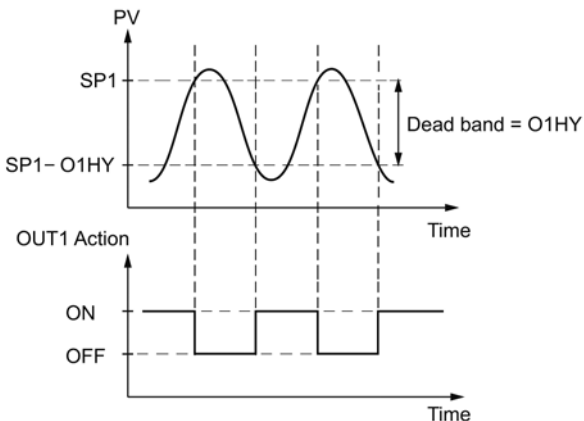

The ON-OFF control may introduce excessive process oscillation even if hysteresis is minimized to the smallest. If ON-OFF control is set (ie. $PB=0$), TI, TD, CYC1, OFST, CYC2, CPB, DB will be hidden and have no function to the system. The auto-tuning mode and bumpless transfer will be disabled too.

Heat only P (or PD) control: Select REVR for OUT1, set TI to 0, OFST is used to adjust the control offset (manual reset). O1HY is hidden if PB is not equal to 0. OFST Function: OFST is measured by % with range 0-100.0%. In the steady state (ie. process has been stabilized) if the process value is lower than the set point a definite value, say 5°C, while 20°C is used for PB, that is lower 25 %, then increase OFST 25%, and vice versa. After adjusting OFST value, the process value will be varied and eventually, coincide with set point. Using the P control (TI set to 0), the auto-tuning is disabled. Refer to section 3-12 „manual tuning“ for the adjustment of PB and TD. Manual reset (adjust OFST) is not practical because the load may change from

time to time and often need to adjust OFST repeatedly. The PID control can avoid this situation.

Heat only PID control: Selecting REVR for OUT1, PB and TI should not be zero. Operate auto-tuning for the new process, or set PB, TI and TD with historical values. See section 3-11 for auto-tuning operation. If the control result is still unsatisfactory, then use manual tuning to improve the control. See section 3-12 for manual tuning. The unit contains a very clever PID and Fuzzy algorithm to achieve a very small overshoot and very quick response to the process if it is properly tuned.

Cool only control: ON-OFF control, P (PD) control and PID control can be used for cool control. Set OUT1 to DIRT (direct action). The other functions for cool only ON-OFF control, cool only P (PD) control and cool only PID control are same as descriptions for heat only control except that the output variable (and action) for the cool control is inverse to the heat control.

Note: The ON-OFF control may result excessive overshoot and undershoot problems in the process. The P (or PD) control will result in a deviation process value from the set point. It is recommended to use PID control for the Heat-Cool control to produce a stable and zero off-set process value.

CPB Programming: The cooling proportional band is measured by % of PB with range 50~300. Initially set 100% for CPB and examine the cooling effect. If cooling action should be enhanced then decrease CPB, if cooling action is too strong then increase CPB. The value of CPB is related to PB and its value remains unchanged throughout the auto-tuning procedures.

Adjustment of CPB is related to the cooling media used. For air is used as cooling media, adjust CPB at 100 (%). For oil is used as cooling media, adjust CPB at 125 (%). For water is used as cooling media, adjust CPB at 250 (%).

DB Programming: Adjustment of DB is dependent on the system requirements. If more positive value of DB (greater dead band) is used, an unwanted cooling action can be avoided but an excessive overshoot over the set point will occur. If more negative value of DB (greater overlap) is used, an excessive overshoot over the set point can be minimized but an unwanted cooling action will occur. It is adjustable in the range -36.0% to 36.0% of PB. A negative DB value shows an overlap area over which both outputs are active. A positive DB value shows a dead band area over which neither output is active.

Figure 3.3 Deviation High Alarm

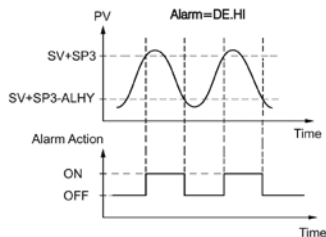
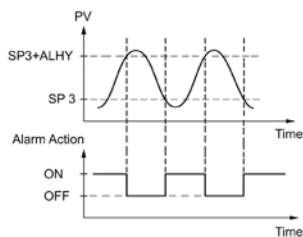

Figure 3.4 Process Low Alarm



The controller has one alarm output. There are 6 types of alarm functions and one dwell timer can be selected, and four kinds of alarm modes (ALMD) are available for each alarm function (ALFN).

A process alarm sets two absolute trigger levels. When the process is higher than SP3, a process high alarm (PV.HI) occurs, and the alarm is off as the process is lower than SP3-ALHY. When the process is lower than SP3, a process low alarm (PV.LO) occurs and the alarm is off as the process is higher than SP3+ALHY. A process alarm is independent of set point.

A deviation alarm alerts the user when the process deviates too far from set point. When the process is higher than SV+SP3, a deviation high alarm (DE.HI) occurs and the alarm is off as the process is lower than SV+SP3-ALHY. When the process is lower than SV+SP3, a deviation low alarm (DE.LO) occurs and the alarm is off as the process is higher than SV+SP3+ALHY. Trigger level of deviation alarm is moving with set point.

A deviation band alarm presets two trigger levels relative to set point. The two trigger levels are $SV+SP3$ and $SV-SP3$ for alarm. When the process is higher than $(SV+SP3)$ or lower than $(SV-SP3)$, a deviation band high alarm (DB.HI) occurs. When the process is within the trigger levels, a deviation band low alarm (DB.LO) occurs.

Normal Alarm: $ALMD=NORM$ When a normal alarm is selected, the alarm output is de-energized in the non-alarm condition and energized in an alarm condition.

Latching Alarm: $ALMD=LTCH$ If a latching alarm is selected, once the alarm output is energized, it will remain unchanged even if the alarm condition is cleared. The latching alarm is reset when the RESET key is pressed, once the alarm condition is removed.

Holding Alarm: $ALMD=HOLD$ A holding alarm prevents an alarm from power up. The alarm is enabled only when

In the above descriptions **SV** denotes the current set point value for control which is different from $SP1$ as the ramp function is performed.

There are four types of alarm modes available for each alarm function, these are: Normal alarm, Latching alarm, Holding alarm and Latching / Holding alarm. They are described as follows:

the process reaches the set point value. Afterwards, the alarm performs same function as normal alarm.

Latching / Holding Alarm: $ALMD=LT.HO$ A latching / holding alarm performs both holding and latching function. The latching alarm is reset when the RESET key is pressed, once the alarm condition is removed.

Alarm Failure Transfer is activated as the unit enters failure mode. Alarm will go on if ON is set for ALFT and go off if OFF is set for ALFT. The unit will enter failure mode when sensor break occurs or if the A-D converter of the unit fails.

The conventional controllers are designed with a fixed parameters' scrolling. If you need a more friendly operation to suit your application, the vender will say „ sorry „, to you. The series have the flexibility for you to select those parameters which are most significant to you and put these parameters in the front of display sequence.

SEL1~SEL8: Selects the parameter for view and change in the user menu.

Range: LOCK, INPT, UNIT, DP, SHIF, PB, TI, TD, O1HY, CYC1, OFST, RR, O2HY, CYC2, CPB, DB, ADDR, ALHY

When using the up-down key to select the parameters, you may not obtain all of the above parameters. The number of visible parameters is dependent on the setup condition. The hidden parameters for the specific application are also deleted from the SEL selection.

Example:

OUT2 selects DE.LO PB= 100.0 SEL1 selects INPT
 SEL2 selects UNIT SEL3 selects PB SEL4 selects TI
 SEL5~SEL8 selects NONE

Now, the upper display scrolling becomes:

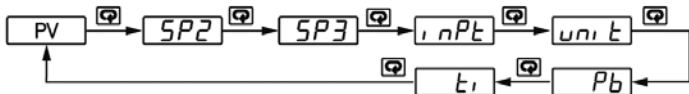

The ramping function is performed during power up as well as any time the set point is changed. Choose MINR or HRR for RAMP, the unit will perform the ramping function. The ramp rate is programmed by adjusting RR. The ramping function is disabled as soon as the failure mode, the manual control mode, the auto-tuning mode or the calibration mode occurs.

Example without Dwell Timer

Select MINR for RAMP, selects °C for UNIT, selects 1-DP for DP, Set RR= 10.0. SV is set to 200 °C initially. The starting temperature is 30 °C. After power up the process is running like the curve shown below:

Figure 3.5 RAMP Function

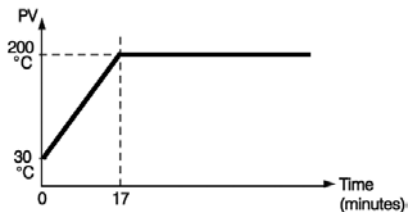

Note: When the ramp function is used, the lower display will show the current ramping value. However it will revert to show the set point value as soon as the up or down key is touched for adjustment. The ramping value is initiated to process value either as power up or RR and / or set point are changed. Setting RR to zero means no ramp function at all.

Alarm output can be configured as dwell timer by selecting TIMR for ALFN. As the dwell timer is configured, the parameter SP3 is used for dwell time adjustment. The dwell time is measured in minute ranging from 0.1 to 4553.6 minutes. Once the process reaches the set point the dwell timer starts to count down until zero (time out). The timer relay will remain unchanged until time out. The dwell timer operation is shown as following diagram.

After time out the dwell timer will be restarted by pressing the RESET key.

The timer stops to count during the manual control mode, failure mode, calibration period and auto-tuning period.

Figure 3.6 Dwell Timer Function

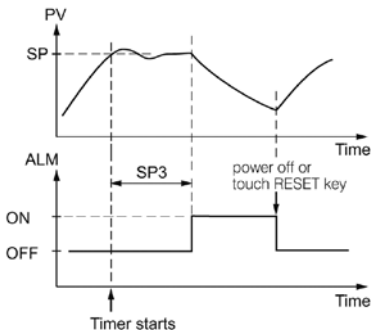

If alarm is configured as dwell timer, ALHY and ALMD are hidden.

In certain applications it is desirable to shift the controller display value from its actual value. This can be easily accomplished by using the PV shift function.

The SHIF function will alter PV only.

Here is an example. A process is equipped with a heater, a sensor and a subject to be warmed up. Due to the design and position of the components in the system, the sensor could not be placed any closer to the part. Thermal gradient (different temperature) is common and

necessary to an extent in any thermal system for heat to be transferred from one point to another. If the difference between the sensor and the subject is 35 °C, and the desired temperature at the subject to be heated is 200 °C, the controlling value or the temperature at the sensor should be 235 °C. You should input -35 °C as to subtract 35 °C from the actual process display. This in turn will cause the controller to energize the load and bring the process display up to the set point value.

Figure 3.7 PV Shift Application

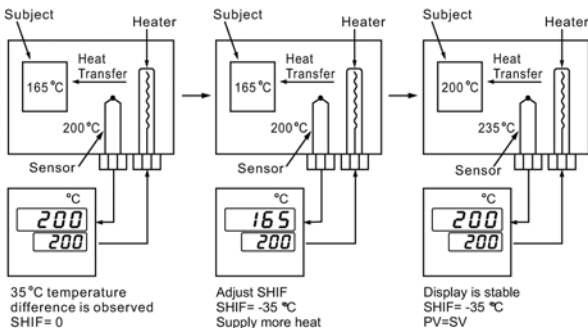

In certain application the process value is too unstable to be read. To improve this a programmable low pass filter incorporated in the controller can be used. This is a first order filter with time constant specified by FILT parameter. The default value of FILT is 0.5 sec. before shipping. Adjust FILT to change the time constant from 0 to 60 seconds. 0 second represents no filter is applied to the input signal. The filter is characterized by the following diagram.

Figure 3.8 Filter Characteristics

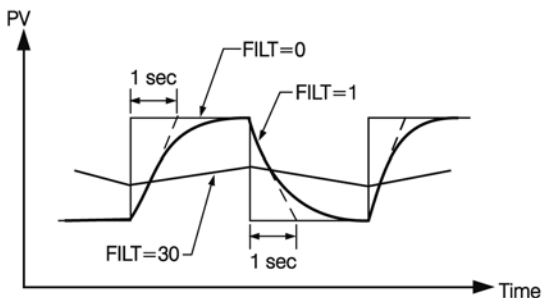

Note: The Filter is available only for PV, and is performed for the displayed value only. The controller is designed to use unfiltered signal for control even if Filter is applied. A lagged (filtered) signal, if used for control, may produce an unstable process.

The controller will enter **failure mode** as one of the following conditions occurs:

1. SBER occurs due to the input sensor break.
2. ADER occurs due to the A-D converter of the controller fails.

The output 1 will perform the failure transfer function as the controller enters failure mode.

Output 1 Failure Transfer, if activated, will perform:

1. If output 1 is configured as proportional control (PB=0), and BPLS is selected for O1FT, then output 1 will perform bumpless transfer. Thereafter the previous averaging value of MV1 will be used for controlling output 1.
2. If output 1 is configured as proportional control (PB=0), and a value of 0 to 100.0 % is set for O1FT, then output 1 will perform failure transfer. Thereafter the value of O1FT will be used for controlling output 1.
3. If output 1 is configured as ON-OFF control (PB=0), then output 1 will transfer to off state if OFF is set for O1FT and transfer to on state if ON is set for O1FT.



Alarm Failure Transfer is activated as the controller enters failure mode. Thereafter the alarm will transfer to the ON or OFF state which is determined by the set value of ALFT.

 The auto-tuning process is performed at set point. The process will oscillate around the set point during tuning process. Set a set point to a lower value if overshooting beyond the normal process value is likely to cause damage.

The auto-tuning is applied in cases of:

- Initial setup for a new process
- The set point is changed substantially from the previous auto-tuning value
- The control result is unsatisfactory

Operation:

1. The system has been installed normally.
2. Set the correct values for the setup menu of the unit. But don't use a zero value for PB and TI, otherwise, the auto-tuning program will be disabled. The LOCK parameter should be set at NONE.
3. Set the set point to a normal operating value or a lower value if overshooting beyond the normal process value is likely to cause damage.
4. Press  and hold until R-t appears on the display.
5. Press  for at least 5 seconds. The AT indicator will begin to flash and the auto-tuning procedure is beginning.

Note: The ramping function, if used, will be disabled once auto-tuning is proceeding. The auto-tuning mode is disabled as soon as either failure mode or manual control mode occurs.

Procedures:

The auto-tuning can be applied either as the process is warming up (Cold Start) or as the process has been in steady state (Warm Start).

After the auto-tuning procedures are completed, the AT indicator will cease to flash and the unit revert to PID control by using its new PID values. The PID values obtained are stored in the nonvolatile memory.

REr Auto-Tuning Error

If auto-tuning fails an ATER message will appear on the upper display in cases of:

- If PB exceeds 9000 (9000 PU, 900.0 °F or 500.0 °C).
- or if TI exceeds 1000 seconds.
- or if set point is changed during auto-tuning procedure.

Solutions to REr

1. Try auto-tuning once again.
2. Don't change set point value during auto-tuning procedure.
3. Don't set zero value for PB and TI.
4. Use manual tuning instead of auto-tuning. (See section 3-12).
5. Touch RESET key to reset REr message.

In certain applications (very few) using auto-tuning to tune a process may be inadequate for the control requirement, then you can try manual tuning.



If the control performance by using auto-tuning is still unsatisfactory, the following rules can be applied for further adjustment of PID values

Adjustment Sequence	Symptom	Solution
(1) Proportional Band (PB)	Slow Response	Decrease PB
	High overshoot or Oscillations	Increase PB
(2) Integral Time (TI)	Slow Response	Decrease TI
	Instability or Oscillations	Increase TI
(3) Derivative Time (TD)	Slow Response or Oscillations	Decrease TD
	High Overshoot	Increase TD

Table 3.2 PID Adjustment Guide

Figure 3.9 shows the effects of PID adjustment on process response.

Operation:

To enable manual control the LOCK parameter should be set with NONE, then press  for 6.2 seconds and H--- (Hand Control) will appear on the display. Press  for 5 seconds then the MAN indicator will begin to flash and the lower display will show H_... The controller now enters the manual control mode. H_... indicates output control variable for output 1, and C_... indicates control variable for output 2. Now you can use up-down key to adjust the percentage values for the heating or cooling output.

The controller performs open loop control as long as it stays in manual control mode.

Exit Manual Control

To press  key the controller will revert to its normal display mode.

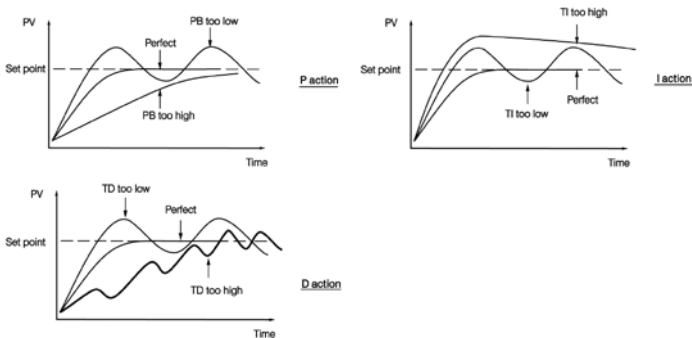
Figure 3.9 Effects of PID Adjustment

Power

90-250 VAC or 11-26 VDC / VAC, 47-63 Hz, 12VA, 5W maximum

Input

Resolution: 18 bits

Sampling Rate: 5 times / second

Maximum Rating: -2 VDC minimum, 12 VDC maximum

Temperature Effect: $\pm 1.5\mu\text{V} / ^\circ\text{C}$

Sensor Lead Resistance Effect:

T/C: $0.2\mu\text{V} / \text{ohm}$

3-wire RTD: $2.6 ^\circ\text{C} / \text{ohm}$ of resistance difference of two leads

2-wire RTD: $2.6 ^\circ\text{C} / \text{ohm}$ of resistance sum of two leads

Burn-out Current: 200 nA

Common Mode Rejection Ratio (CMRR): 120dB

Normal Mode Rejection Ratio (NMRR): 55dB

Sensor Break Detection:

Sensor open for TC, RTD

Sensor short for RTD input

Sensor Break Responding Time :

Within 4 seconds for TC and RTD

Characteristics:

Type	Range	Accuracy @ 25 C	Input Impedance
J	-120°C-1000°C (-184°F-1832°F)	±2°C	2.2 MΩ
K	-200°C-1370°C (-328°F-2498°F)	±2°C	2.2 MΩ
T	-250°C-400°C (-418°F-752°F)	±2°C	2.2 MΩ
E	-100°C-900°C (-148°F-1652°F)	±2°C	2.2 MΩ
B	0°C-1800°C (32°F-3272°F)	±2 °C (200°C-1800°C)	2.2 MΩ
R	0°C-1767.8°C (32°F-3214°F)	±2°C	2.2 MΩ
S	0°C 1767.8°C (32°F-3214°F)	±2°C	2.2 MΩ
N	-250°C-1300°C (-418°F-2372°F)	±2°C	2.2 MΩ
L	-200°C-900°C (-328°F-1652°F)	±2°C	2.2 MΩ
PT100 (DIN)	-210°C-700°C (-346°F-1292°F)	±0.4°C	1.3 KΩ
PT100 (JIS)	-200°C-600°C (-328°F-1112°F)	±0.4°C	1.3 KΩ

OUTPUT

Pulsed Voltage: Source Voltage 14V DC / max. load=40mA

ALARM

Alarm Relay: Form C Rating 2A / 240VAC, life cycles 200,000 for resistive load.

Alarm Functions: Dwell timer, Deviation High / Low Alarm, Deviation Band High / Low Alarm, PV High / Low Alarm,

Alarm Mode: Normal, Latching, Hold, Latching / Hold.

Dwell Timer: 0.1-4553.6 minutes

USER INTERFACE**Dual 4-digit LED Displays****Keypad:** 4 keys**Control Mode Output 1:** Reverse (heating) or direct (cooling) action**ON-OFF:** 0.1-90.0 (°F) hysteresis control (P band = 0)**P or PD:** 0-100.0% offset adjustment**PID:** Fuzzy logic modified

Proportional band 0.1 ~ 900.0 °F

Integral time 0-1000 seconds

Derivative time 0-360.0 seconds

Cycle Time: 0.1-90.0 seconds**Manual Control:** Heat (MV1) and Cool (MV2)**Auto-tuning:** Cold start and warm start**Failure Mode:** Auto-transfer to manual mode while sensor break or A-D converter damage**Ramping Control:** 0-900.0 °F / minute or 0-900.0 °F / hour ramp rate**DIGITAL FILTER****Function:** First order Time Constant: 0, 0.2, 0.5, 1, 2, 5, 10, 20, 30, 60 seconds programmable

ENVIRONMENTAL AND PHYSICAL

Operating Temperature: -10 °C to 50 °C

Storage Temperature: -40 °C to 60 °C

Humidity: 0 to 90 % RH (non-condensing)

Altitude: 2000m maximum

Pollution: Degree 2

Insulation Resistance: 20 Mohms min. (at 500 VDC)

Dielectric Strength: 2000 VAC, 50 / 60 Hz for 1 minute

Vibration Resistance: 10-55 Hz, 10 m/s² for 2 hours

Shock Resistance: 200 m/s² (20 g)

Moldings: Flame retardant polycarbonate

Dimensions: 48mm(W) X 48mm(H) X 116mm(D), 105 mm depth behind panel

Weight: 150 grams

Protective Class: IP65 for panel. All indoor use.

TABLE A.1 ERROR CODES AND CORRECTIVE ACTIONS

Error Code	Display Symbol	Error Description	Corrective Action
4	E-04	Illegal setup values been used: Before COOL is used for OUT2, DIRT (cooling action) has already been used for OUT1, or PID mode is not used for OUT1 (that is PB=0, and / or TI=0)	Check and correct setup values of OUT2, PB, TI and OUT1. IF OUT2 is required for cooling control, the control should use PID mode (PB=0, TI=0) and OUT1 should use reverse mode (heating action), otherwise, don't use OUT2 for cooling control.
10	E-10	Communication error: bad function code	Correct the communication software to meet the protocol requirements.
11	E-11	Communication error: register address out of range	Don't issue an over-range register address to the slave.
14	E-14	Communication error: attempt to write a read-only data or a protected data	Don't write a read-only data or a protected data to the slave.
15	E-15	Communication error: write a value which is out of range to a register	Don't write an over-range data to the slave register.
26	RtEr	Fail to perform auto-tuning function	<ol style="list-style-type: none"> 1. The PID values obtained after auto-tuning procedure are out of range. Retry auto-tuning. 2. Don't change set point value during auto-tuning procedure. 3. Use manual tuning instead of auto-tuning. 4. Don't set a zero value for PB. 5. Don't set a zero value for TI. 6. Touch RESET key
29	EEPE	EEPROM can't be written correctly	Return to factory for repair.
30	CJEr	Cold junction compensation for thermocouple malfunction	Return to factory for repair.
39	SbEr	Input sensor break	Replace input sensor.
40	RdEr	A to D converter or related component(s) malfunction	Return to factory for repair.



hotset

Hotset GmbH
Hueckstraße 16
58511 Lüdenscheid
Germany

Phone +49 / 23 51 / 43 02-0

www.hotset.com